

Vacuum cup UPG600

Vacuum technology | Uplifter

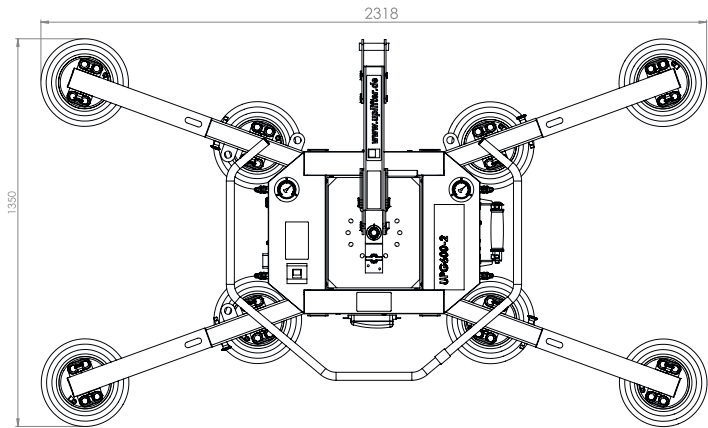

Load capacity	kg 600 kg
Suction disc quantity	8 Pieces
Suction plate Diameter	Ø 300 mm
Curved discs	✗
Lowering cylinder	✗
Radio remote control	✓ optional
Dead weight max.	89,0 kg
Length max./min.	2,57/1,13 m
Wide max./min.	1,35/0,91 m
Inclination angle	90°
Rotatability	360° in 45° grid
Operating time	approx. 8.0 hours



Load capacity 300 kg

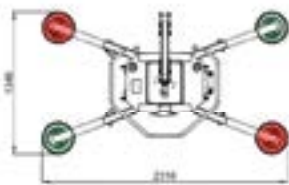
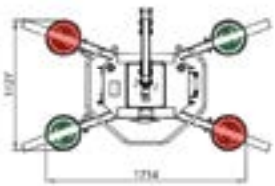
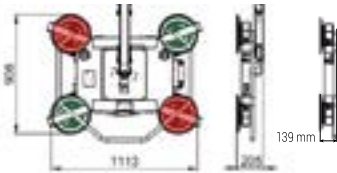

Load capacity 600 kg

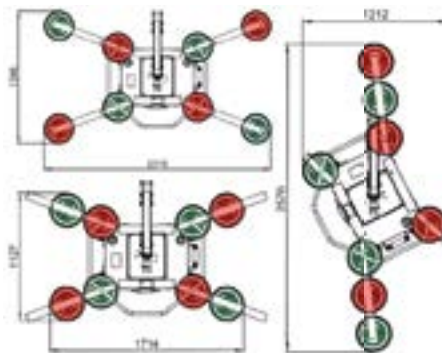

Load capacity 450 kg/300 kg

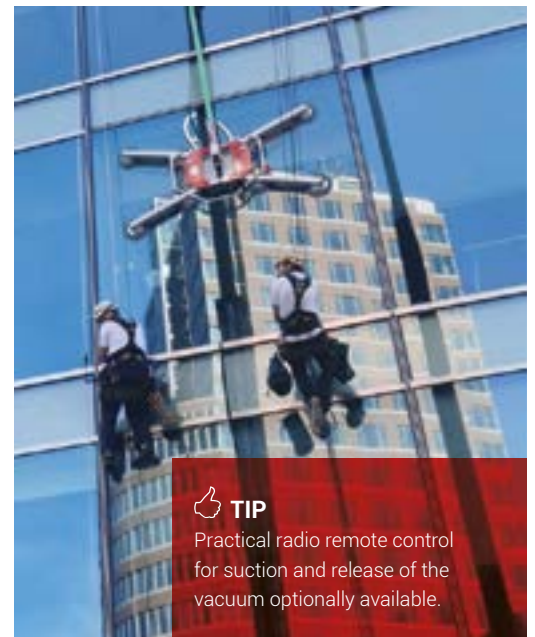
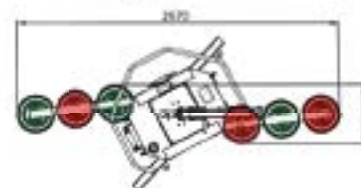
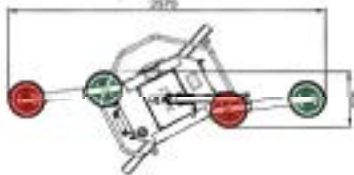
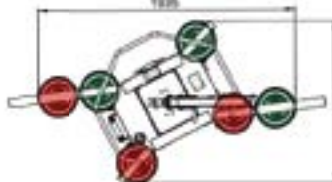
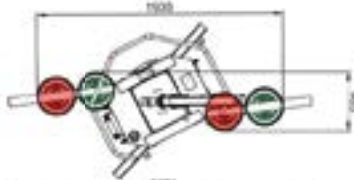

TIP
Practical radio remote control for suction and release of the vacuum optionally available.

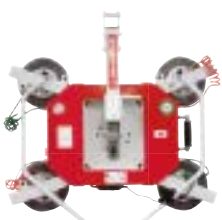

Due to the different arrangement of the suction plates, the vacuum cup can be optimally adapted to a wide range of pane sizes.